

12AYM-WET

M-rating 1220kW [1659mhp] / H-rating 1140kW [1550mhp]

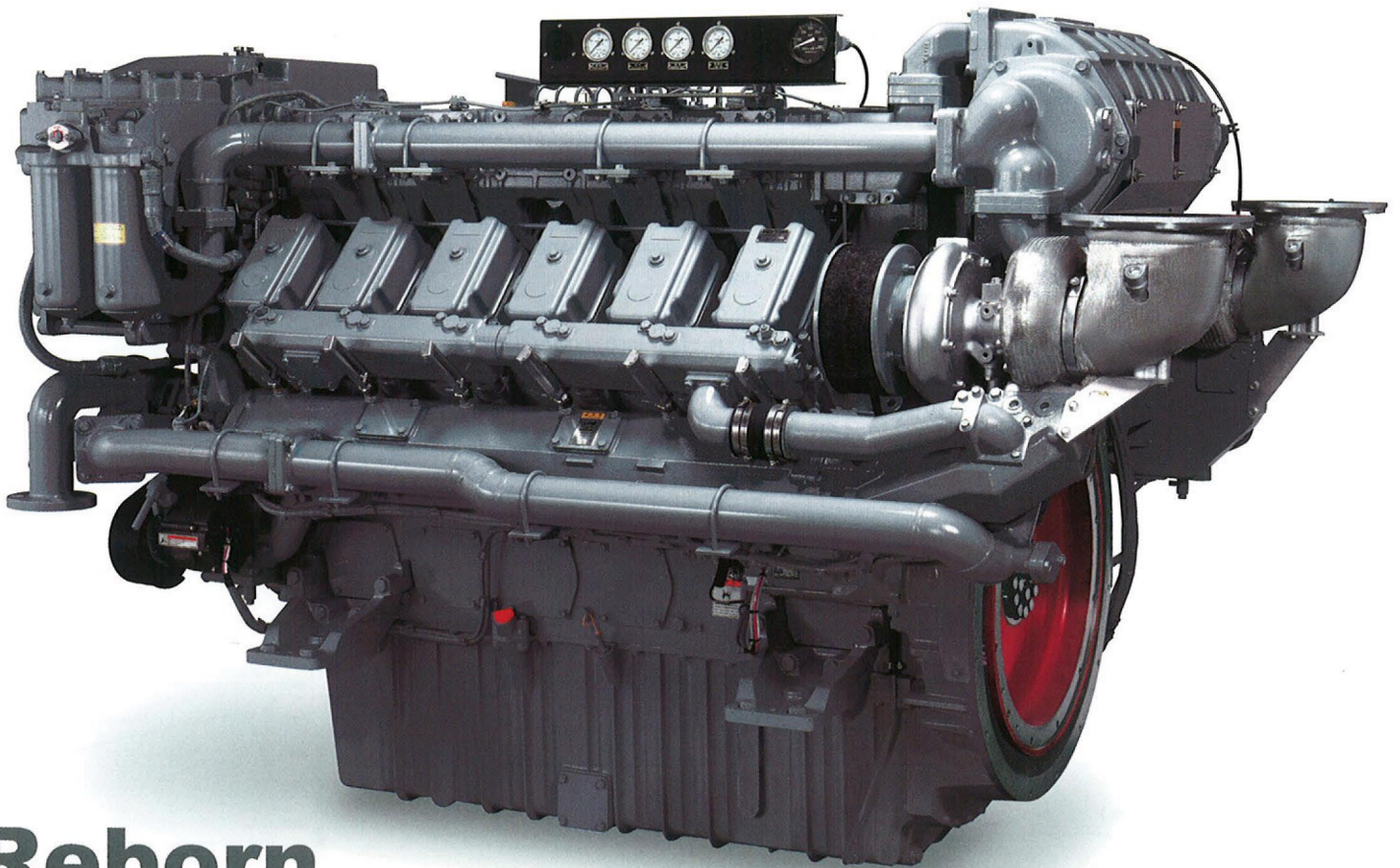

Photograph may show optional equipment.

Reborn **Power and Quality**

IMO TierII Compliant / Mechanical Engine Control

1550 mhp
1659 mhp

**LONG
STROKE**

Reborn V12 power you can rely on, developed from years of experience with the latest technology

Since the 12LA and 16LA series engines were first sold in 1980's, Yanmar has supplied more than 2,000 of them around the world. Based on this success, we have developed the new 12AY series, a reliable, high-performance V12 engine reborn as our 1,000 hp-plus high-power model. We use the same proven technology from our best-selling 6AY series, meeting IMO Tier II exhaust emission standards without electronic engine control. With its stable high torque, this engine features a prolonged lifecycle design that boasts low NOx and fuel consumption thanks to a new, efficient combustion method, improved durability, and ease of maintenance. This engine will help cut costs and reduce downtime.

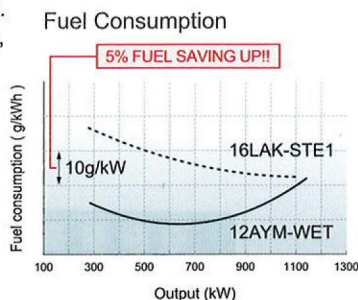

Engine Specifications

Model		12AYM-WET	
Type	V-type, vertical, water-cooled, 4-cycle diesel engine		
No. of cylinders, Bore × stroke mm	12, 155 × 180		
Displacement	lit.	40.76	
Rated output	kW(hp) / rpm	M: 1220 (1659) / 1900 (at flywheel)	H: 1140 (1550) / 1840 (at flywheel)
Emission	IMO Tier II		
Fuel consumption	gr/kW · hr	M: 217 ^{+5%} (without marine gear)	H: 212 ^{+5%} (without marine gear)
Direction of rotation		Counterclockwise, when viewed from the flywheel side (crankshaft)	
Combustion system	Direct injection		
Cooling system	Constant high temperature cooling system		
Cooling fresh water capacity	lit.	211 (jacket)	
Lubricating system	Wet sump system, forced lubrication by gear pump		
Lubricating oil capacity	lit.	Max.: 170 Min.: 110 (sump tank) (in engine piping line: 25)	
Lubricating oil grade	SAE40 or SAE15W-40		
Starting system	Electric starting motor DC24V-6.5kW×2 or air motor×2		
Flywheel housing size	inch	SAE #0, 21	
Dry weight	kg	4720	

Dimensions (Unit : mm)

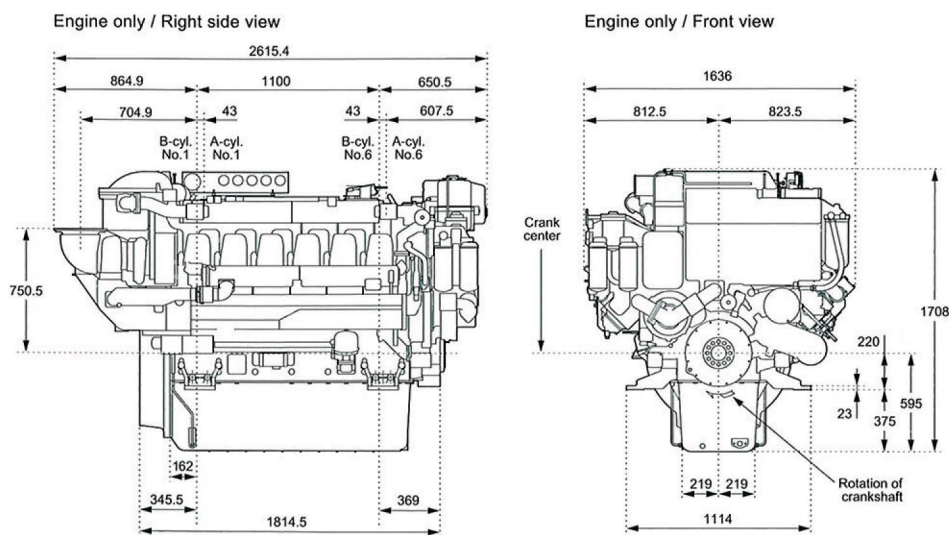

Authorised Distributor:

PANSAR

Pansar Company Sdn. Bhd. 19650100061 (50977M)

Wisma Pansar, 23-27 Jalan Bengkel, P.O.Box 319, 96007 Sibul, Sarawak.

H +6084-333 366 : +6084-314 555 9 marine.industrial@pansar.com.my K pansar.com.my

Kuala Lumpur Regional Office

No. 7 Jalan Astaka, U8/84, Bukit Jelutong Industrial Park, Seksyen U8, 40150 Shah Alam, Selangor.

H +603-7845 3366 : +603-7846 9031

Kuala Lumpur +603-7845 3366 **Johor Bahru** +607-562 5166 **Muar** +606-951 0386 **Ipoh** +605-282 6382 **Penang** +604-530 2417

Sibu +6084-322 022 **Kuching** +6082-244 155 **Bintulu** +6086-331 720 **Miri** +6085-424 716 **Kota Kinabalu** +6088-218 811

Sandakan +6089-217 799 **Tawau** +6089-776 355 **Lahad Datu** +6089-886 355 **Brunei** +673-223 3641 **Singapore** +65-6353 3933

Performance Curves

M rating

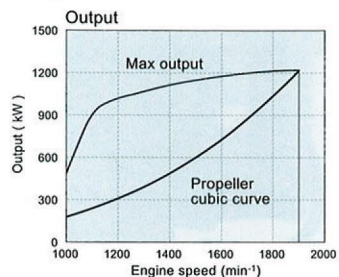
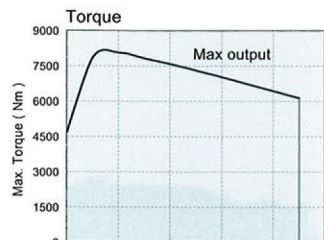
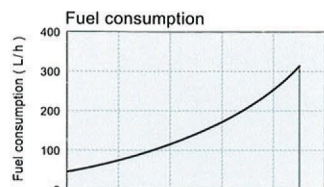

H rating

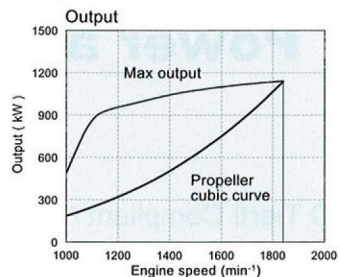
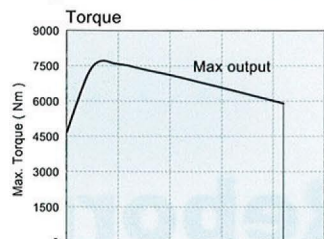
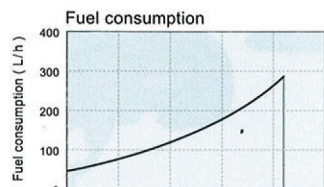

Rating definitions : hp=0.7355kW Ratings are based on conditions of 100kPa, 30% relative humidity at 25°C.
M=For applications where use of rated power is less than 10 hours continuous and operation is less than 3000 hours per year.
H=For applications where use of rated power is less than 24 hours continuous and operation is less than 4000 hours per year.
Fuel rates : Specific gravity 0.835g/cc, low calorific value 42700kJ/kg (10200kcal/kg), Cetane No.45.

Powered by **YANMAR**